

RoHS

REV.	EC#	DESCRIPTION	DATE	DRAWING	CHECKED	APPROVED
A0		NEW RELEASE	2018.06.25	Michael	Mark	Cornelia

A

B

C

D

E

A

B

C

D

E

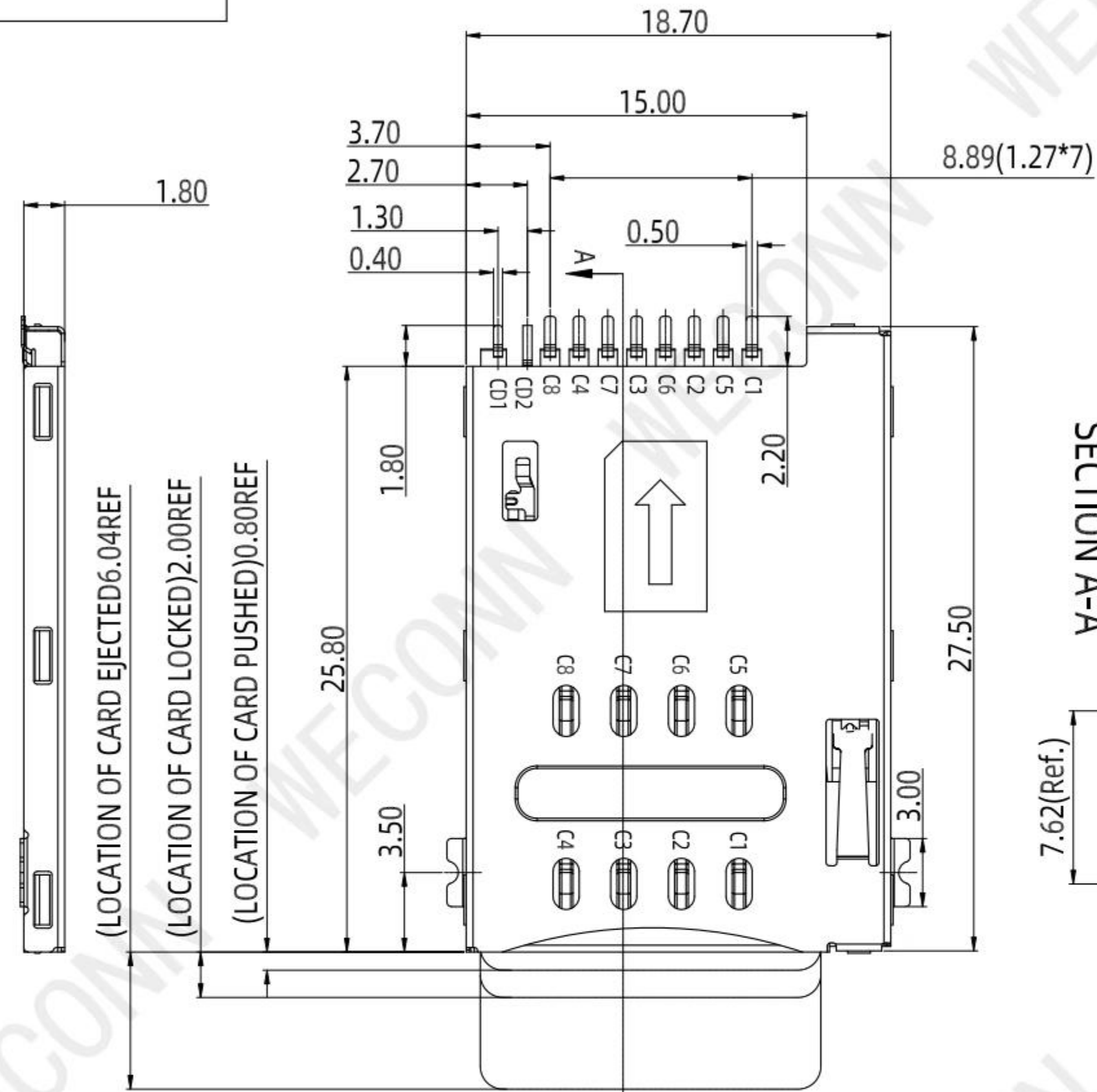

SECTION A-A

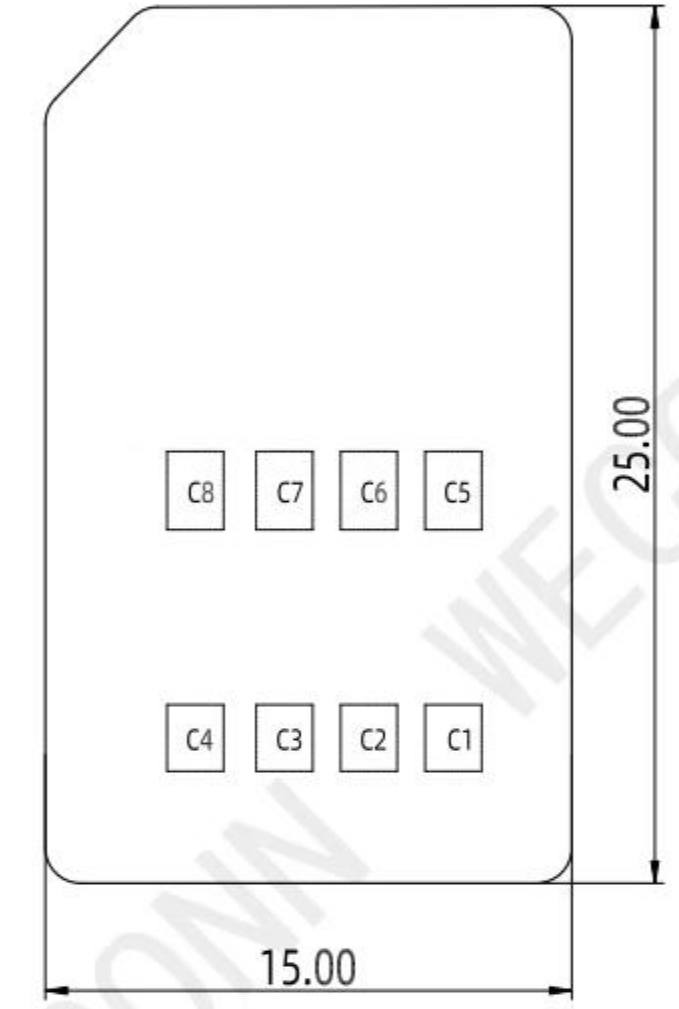
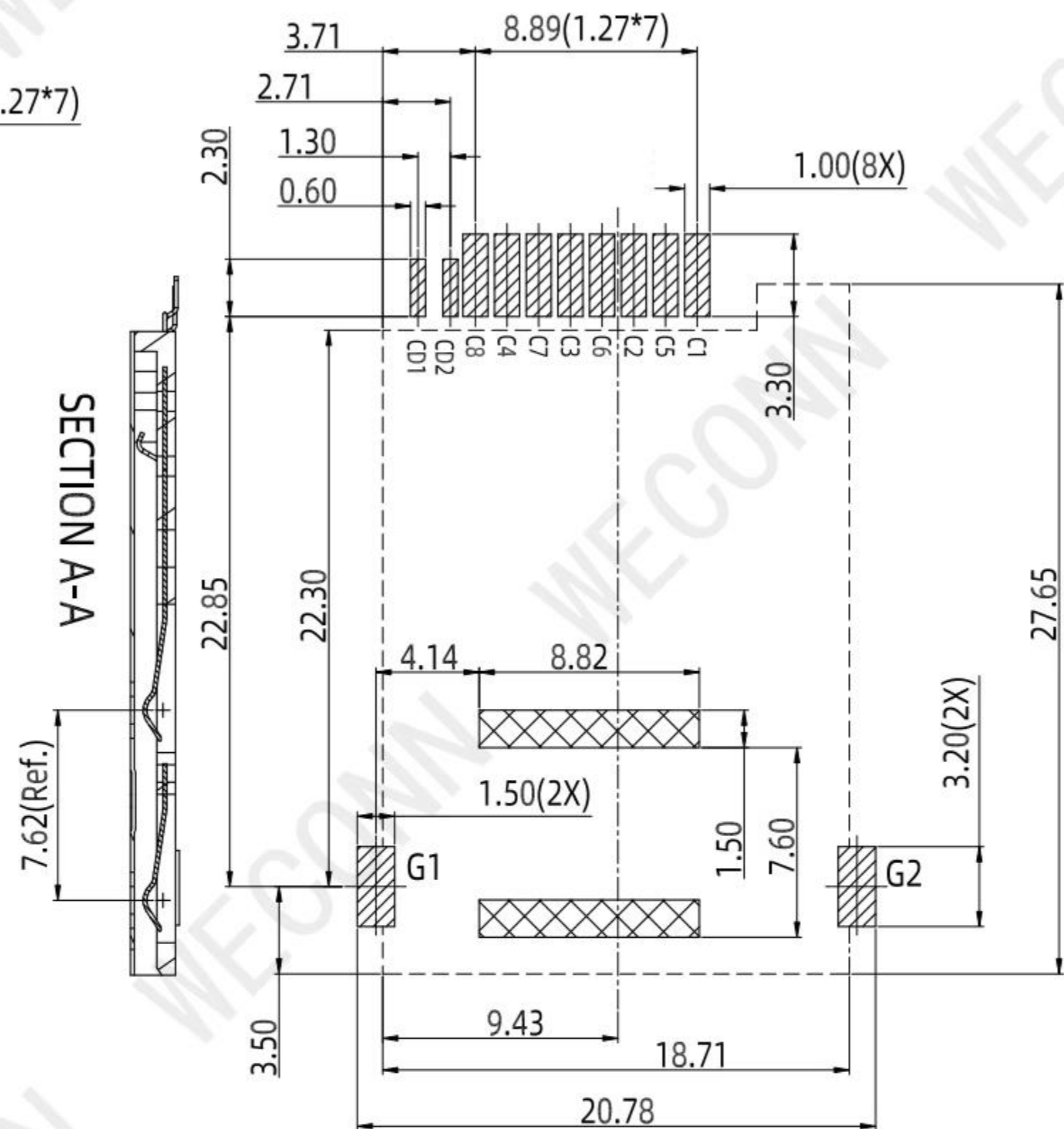

SIM 示意图

NOTES:

MATERIAL:

Insulator: High Temperature Thermoplastic, UL 94V-0.  
 Contact: Copper Alloy  
 CD PIN: Copper Alloy  
 Shell: STAINLESS

Electrical:

Current Rating :0.5A AC/DC max.  
 Voltage Rating :30V AC/DC  
 Ambient Temperature Range :-20°C~+60°C  
 Storage Temperature Range :-40°C~+70°C  
 Ambient Humidity Range :95% R.H. Max.  
 Contact Resistance:100mΩmax.  
 Insulation Resistance:1000MΩmin./500VDC  
 Mating Cycles:5,000 Insertions  
 Temperature: 260°C ±5°

PLEASE CONTACT WELINK SALES REPRESENTATIVE TO VERIFY PRODUCT DETAILS & AVAILABILITY

RECOMMENDED P.C.B LAYOUT COMPONENT SIDE(TOLERANCE ±0.05)

- PAD AREA
- KEEP AREA
- KEEP OUT AREA

G1-GN pin is defined as GND

ELECTRIC FUNCTION	DETECT SWITCH
WITHOUT CARD	OPEN
CARD INSERTED	CLOSED

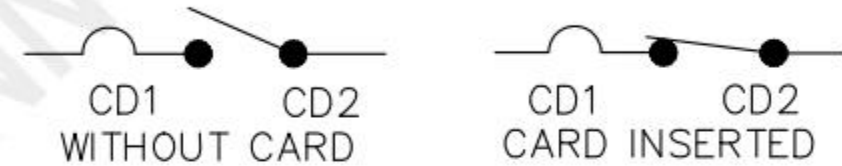

SWITCH OPERATION DIAGRAM

SIM CARD	
Pin No.	NAME
C1	VCC
C2	RST
C3	CLK
C4	RESERVED
C5	GND
C6	VPP
C7	I/O
C8	RESERVED
CD1	C/D
CD2	GND

MILLIMETERS	INCH	UNITS
		MM
X.° ± 2°	X.° ± 2°	
.X ± 0.30	.XX ± 0.012	
.XX ± 0.20	.XXX ± 0.008	
.XXX ± 0.10	.XXXX ± 0.004	

**WECONN** 深圳市微连电子有限公司  
 ShenZhen Welink Electronics Co.,Ltd

PART NUMBER: <b>WL-SIM720-003</b>		TITLE: SIM卡座 自弹式 8P 带开关	
DWG NO.: <b>WL-SIM720-003</b>		APPD:	<b>Cornelia</b>
SCALE	SHEET	CHKD:	<b>Mark</b>
1:1	1/2	DR:	<b>Michael</b>
		REV.	<b>A1</b>

RoHS

REV.	EC#	DESCRIPTION	DATE	DRAWING	CHECKED	APPROVED
A0		NEW RELEASE	2018.06.25	Michael	Mark	Cornelia

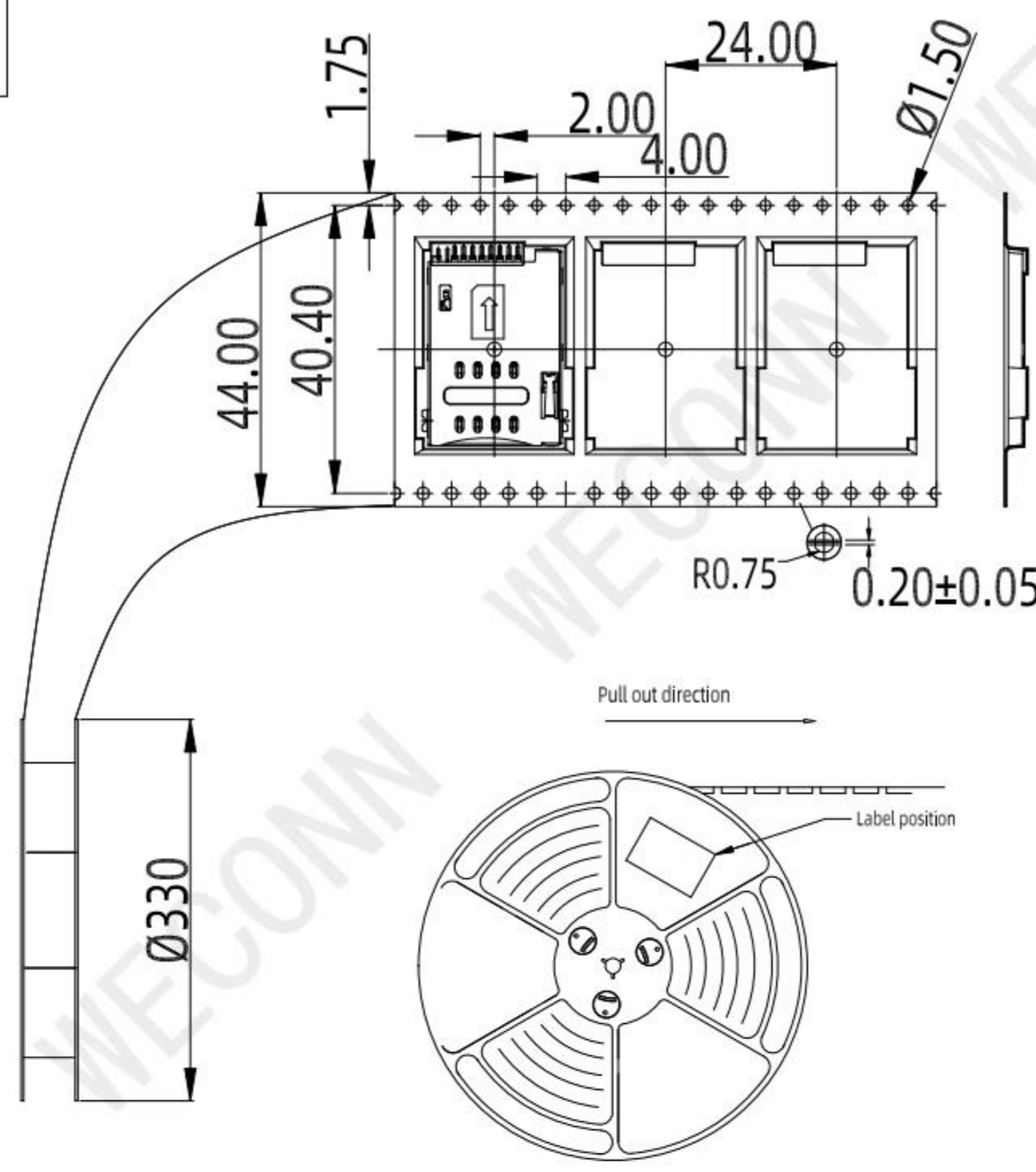

NOTES

- 1. NUMBER OF CONNECTORS: 650PCS/REEL
- 2. LEAD TAPE LENGTH

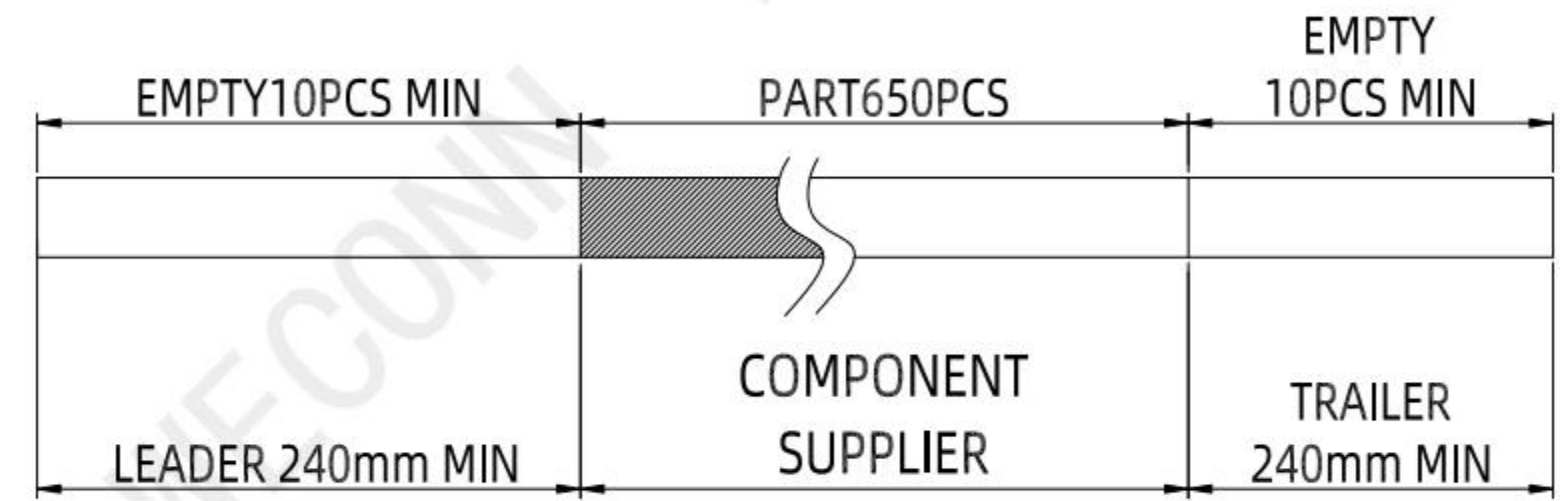

3. QUANTITY: 3900PCS/CARTON

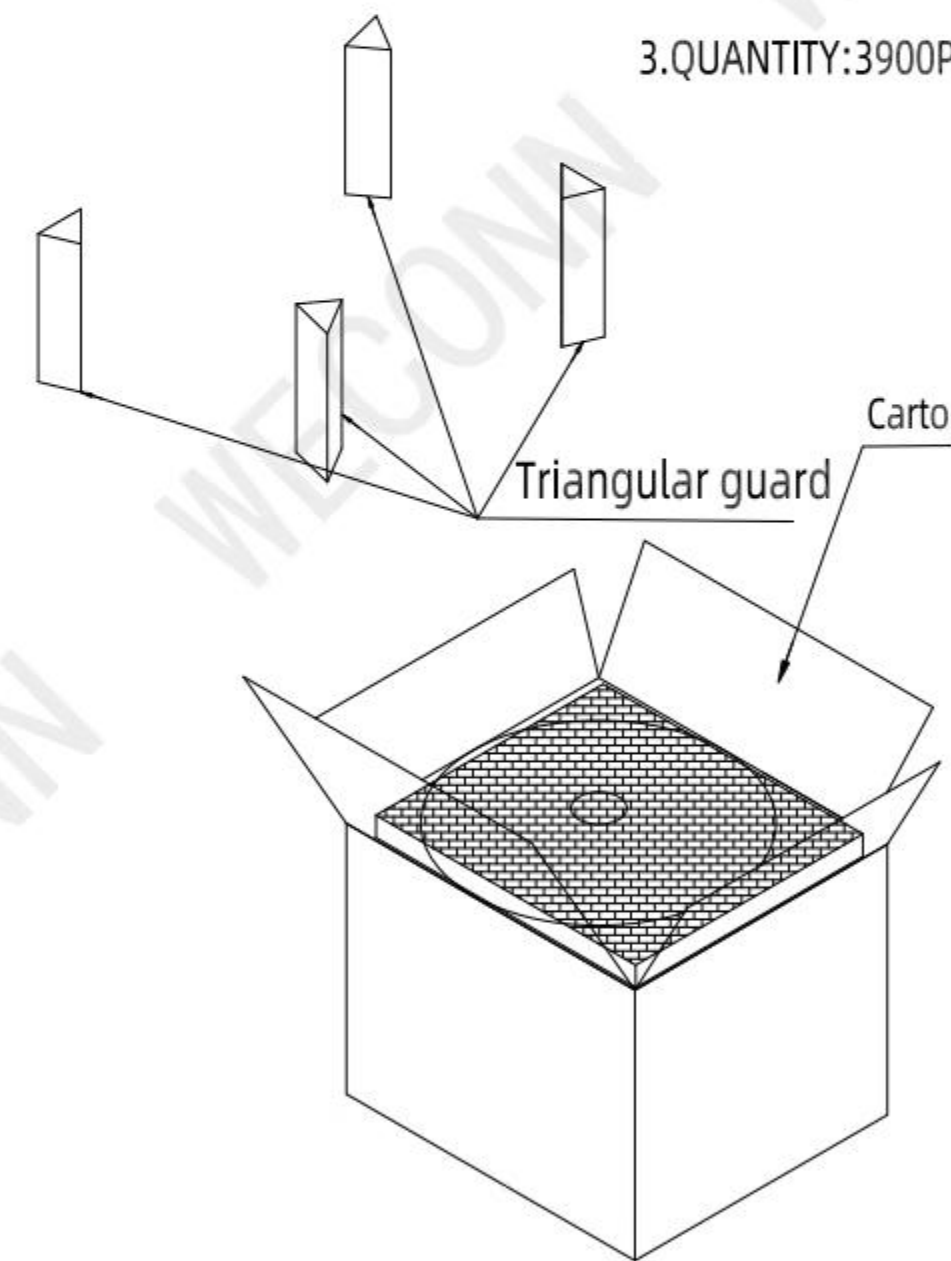

Use three tapes to seal the box as shown

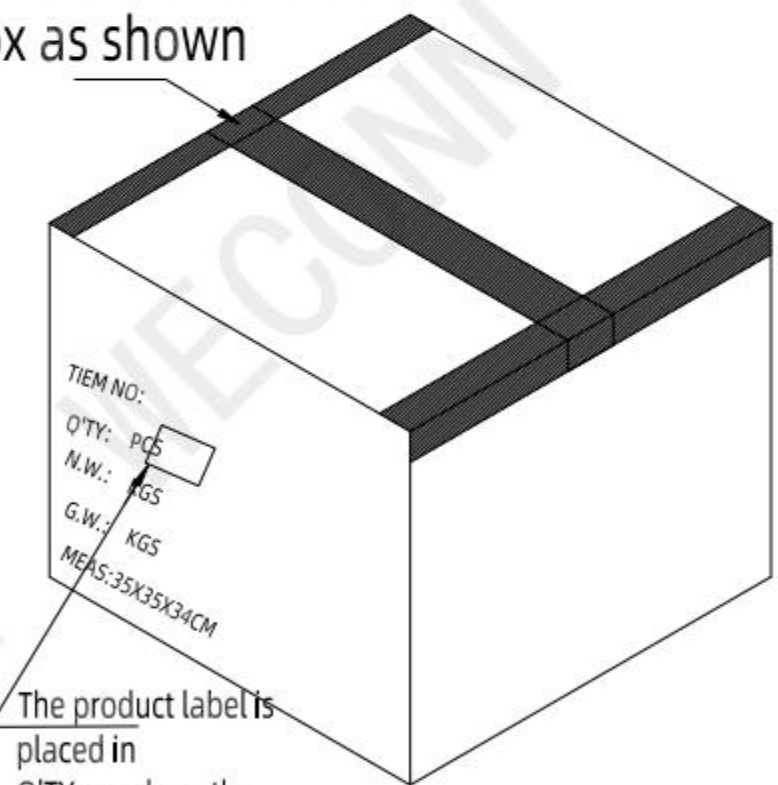

The product label is placed in Q'TY: and pcs the middle

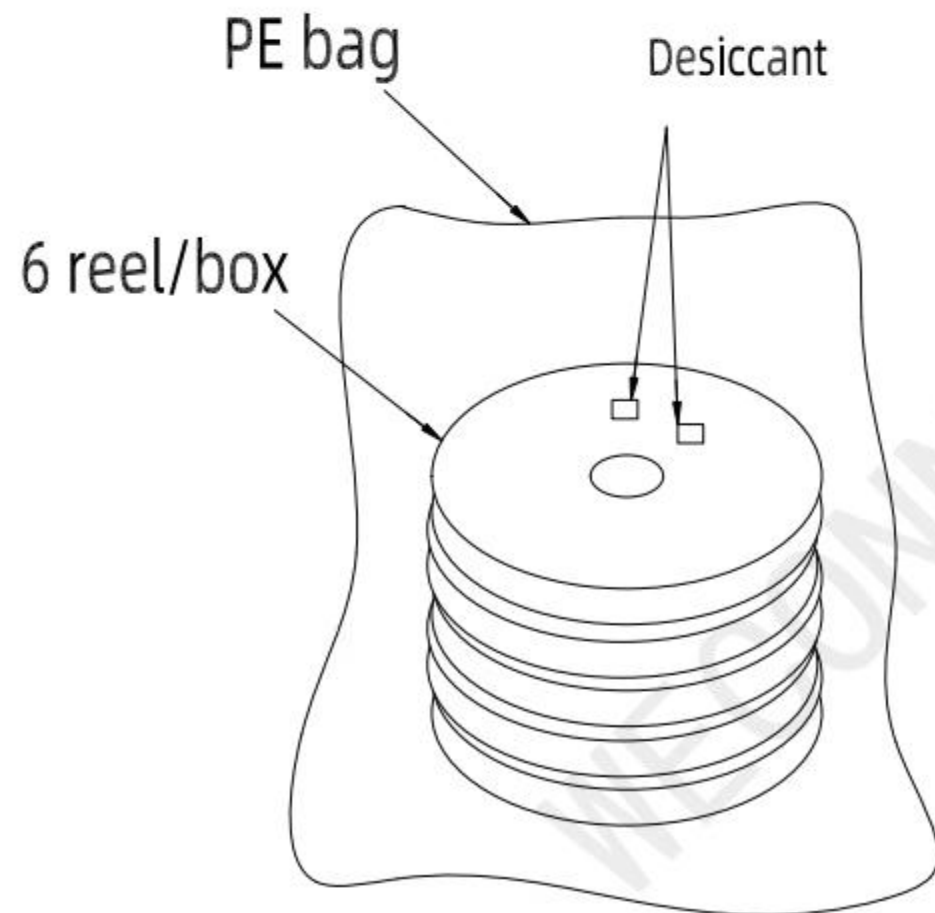

MILLIMETERS	INCH	UNITS	WECONN® 深圳市微连电子有限公司 ShenZhen Welink Electronics Co.,Ltd			
X.° ± 2°	X.° ± 2°	MM	PART NUMBER: WL-SIM720-003		TITLE: SIM卡座 自弹式 8P 带开关	
.X ± 0.30	.XX ± 0.012	MAT'L SEE NOTES	DWG NO.: WL-SIM720-003		APPD:	Cornelia
.XX ± 0.20	.XXX ± 0.008	FINISH SEE NOTES	SCALE	SHEET	REV.	CHKD:
.XXX ± 0.10	.XXXX ± 0.004	QTY SEE NOTES	1:1	2/2	A1	DR:
THESE DRAWINGS AND PECIFICATION ARE Wellink ShenZhen Welink Electronics Co.,Ltd COPIED OR USED IN ANY MANNER WITHOUT Wellink ShenZhen Welink Electronics Co.,Ltd					Michael	